

MA07-150

CEILING SHOWER ARM

meir®

MATTE BLACK
MA07-150

CHROME
MA07-150-C

CHAMPAGNE
MA07-150-CH

TIGER
BRONZE
MA07-150-BB

BRUSHED
NICKEL
MA07-150-
-PVDBN

AVAILABLE
FINISHES



FEATURES

- 10 Year warranty
- Solid brass construction
- Box Weight 0.5kg
- 68mm long 1/2" threaded adapter included

CARE

- Do not install tapware using any form of acetone silicones.
- Do not apply physical items (such as tools) directly to product.
- Never use house-hold or commercial detergents, citrus based cleaners, or abrasive cleaners.
- Clean using a mild washing soap solution rinsed, and dry with a soft cloth.
- Check for any product defects before installation.
- Refer to the installation manual for correct installation.

SPECIFICATIONS

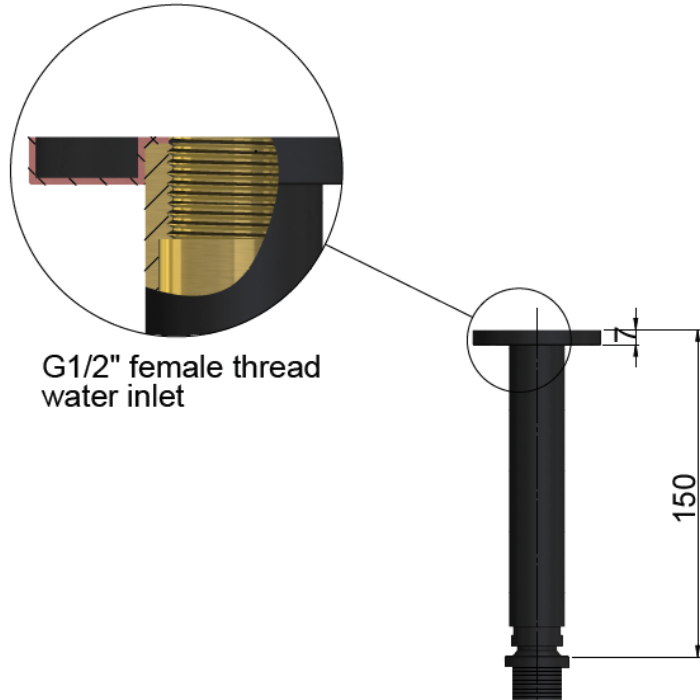

EXPLODED VIEW

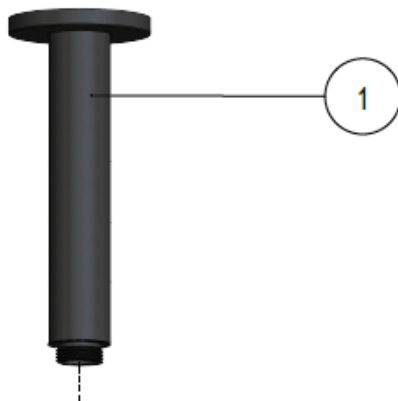

No.	Part Name
1	Ceiling Arm

MA07-300

CEILING SHOWER ARM



meir®

MATTE BLACK
MA07-300

CHROME
MA07-300-C

CHAMPAGNE
MA07-300-CH

**TIGER
BRONZE**
MA07-300-BB

**BRUSHED
NICKEL**
MA07-300-
-PVDBN

**AVAILABLE
FINISHES**

FEATURES

- 10 Year warranty
- Solid brass construction
- Box Weight 0.6kg
- 68mm long 1/2" threaded adapter included

CARE

- Do not install tapware using any form of acetone silicones.
- Do not apply physical items (such as tools) directly to product.
- Never use house-hold or commercial detergents, citrus based cleaners, or abrasive cleaners.
- Clean using a mild washing soap solution rinsed, and dry with a soft cloth.
- Check for any product defects before installation.
- Refer to the installation manual for correct installation.

SPECIFICATIONS

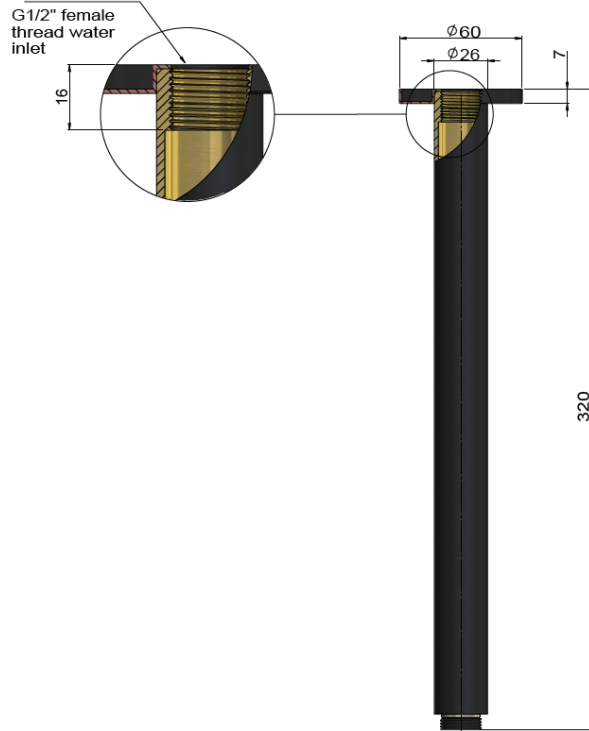

EXPLODED VIEW

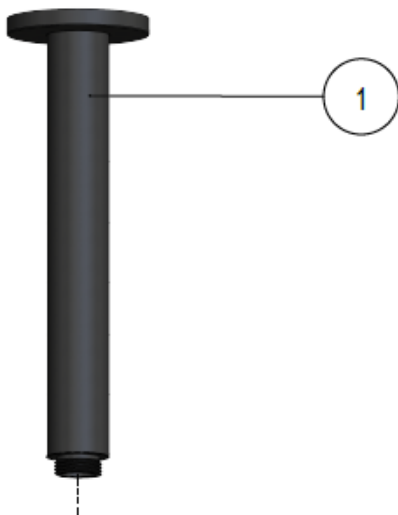

No.	Part Name
1	Ceiling Arm

MH04 SHOWER ROSE

meir®

MATTE BLACK
MH04

CHROME
MH04-C

CHAMPAGNE
MH04-CH

**TIGER
BRONZE**
MH04-BB

**BRUSHED
NICKEL**
MH04-PVDBN

**AVAILABLE
FINISHES**



FEATURES

- 10 Year warranty
- Flow rate 9L p/m
- Solid brass construction
- Box Weight 1.1 Kg

CARE

- Do not install tapware using any form of acetone silicones.
- Do not apply physical items (such as tools) directly to product.
- Never use house-hold or commercial detergents, citrus based cleaners, or abrasive cleaners.
- Clean using a mild washing soap solution rinsed, and dry with a soft cloth.
- Check for any product defects before installation.
- Refer to the installation manual for correct installation.

SPECIFICATIONS

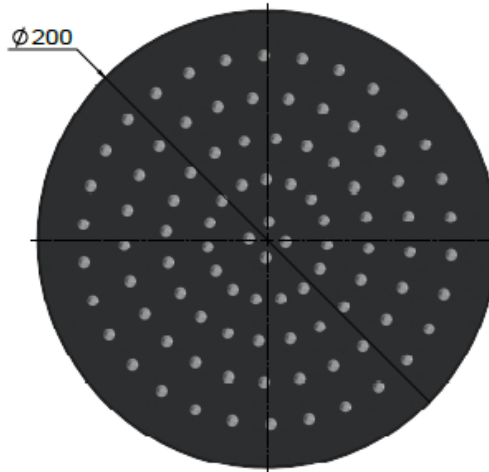
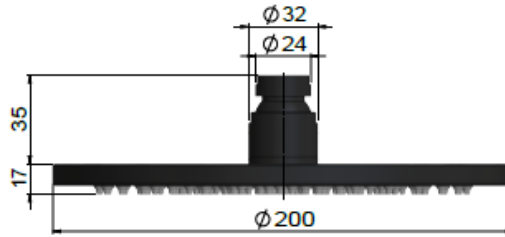

FLOW RATE GRAPH

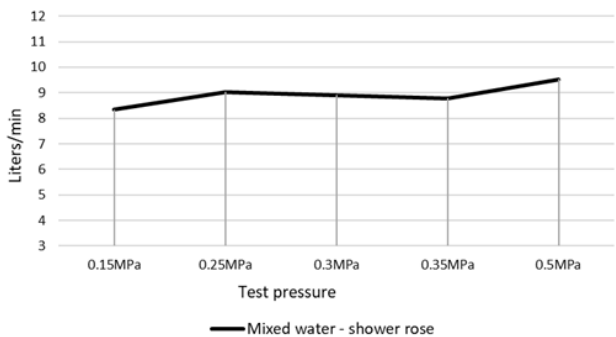

CREDENTIALS

- Watermark AS/NZS3718WMKA25013
- Wels Rated 3 Star

EXPLODED VIEW

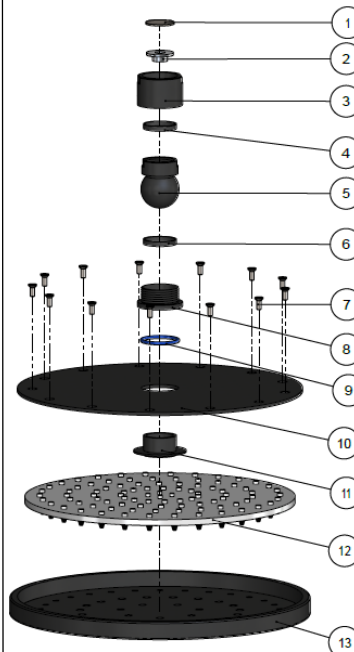

No.	Part Name
1	Strainer
2	Flow Controller
3	Nut
4	Wearing Ring
5	Universal Ball
6	Wearing Ring
7	Screw
8	Connet Nut
9	O-ring
10	Cover Plate
11	Connector
12	Rubber Gasket
13	Plate

MH05 SHOWER ROSE

meir®

MATTE BLACK
MH05

CHROME
MH05-C

CHAMPAGNE
MH05-CH

**TIGER
BRONZE**
MH05-BB

**BRUSHED
NICKEL**
MH05-PVDBN

**AVAILABLE
FINISHES**



FEATURES

- 10 Year warranty
- Flow rate 9L p/m
- Solid brass construction
- Box Weight 1.4 Kg

CARE

- Do not install tapware using any form of acetone silicones.
- Do not apply physical items (such as tools) directly to product.
- Never use house-hold or commercial detergents, citrus based cleaners, or abrasive cleaners.
- Clean using a mild washing soap solution rinsed, and dry with a soft cloth.
- Check for any product defects before installation.
- Refer to the installation manual for correct installation.

SPECIFICATIONS

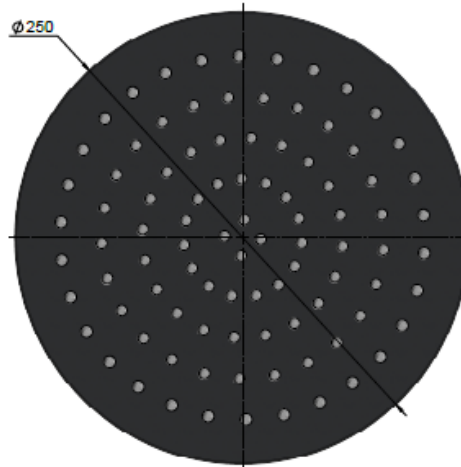
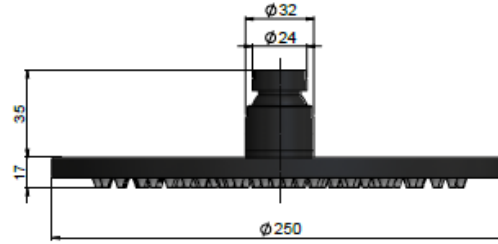

FLOW RATE GRAPH

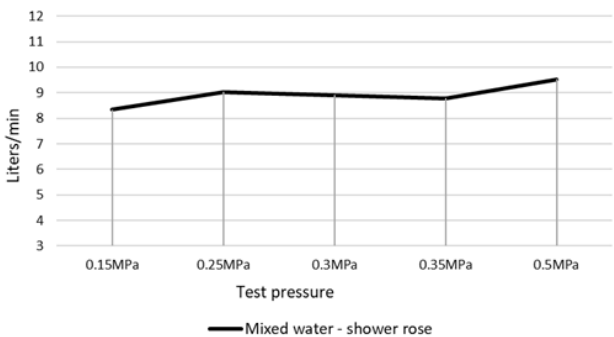

CREDENTIALS

- Watermark AS/NZS3718WMKA25013
- Wels Rated 3 Star

EXPLODED VIEW

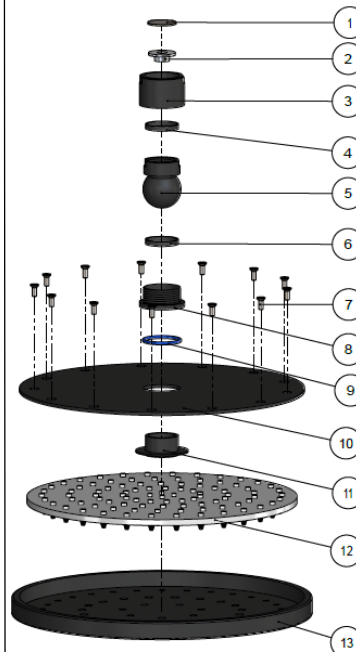

No.	Part Name
1	Strainer
2	Flow Controller
3	Nut
4	Wearing Ring
5	Universal Ball
6	Wearing Ring
7	Screw
8	Connet Nut
9	O-ring
10	Cover Plate
11	Connector
12	Rubber Gasket
13	Plate

MH06

SHOWER ROSE

meir®

MATTE BLACK
MH06

CHROME
MH06-C

CHAMPAGNE
MH06-CH

**TIGER
BRONZE**
MH06-BB

**BRUSHED
NICKEL**
MH06-PVDBN

**AVAILABLE
FINISHES**



FEATURES

- 10 Year warranty
- Flow rate 9L p/m
- Solid Brass construction
- Box Weight 2.0 Kg

CARE

- Do not install tapware using any form of acetone silicones.
- Do not apply physical items (such as tools) directly to product.
- Never use house-hold or commercial detergents, citrus based cleaners, or abrasive cleaners.
- Clean using a mild washing soap solution rinsed, and dry with a soft cloth.
- Check for any product defects before installation.
- Refer to the installation manual for correct installation.

SPECIFICATIONS

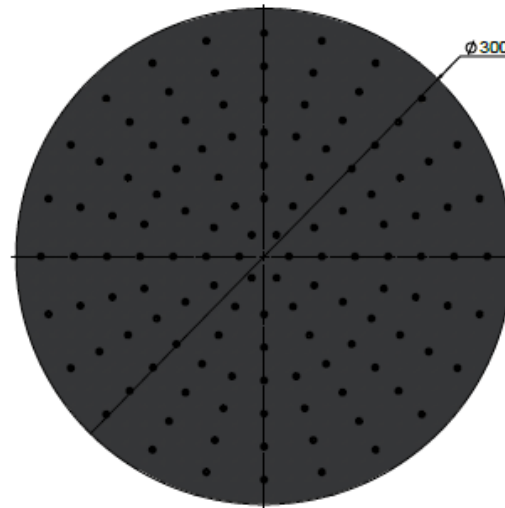
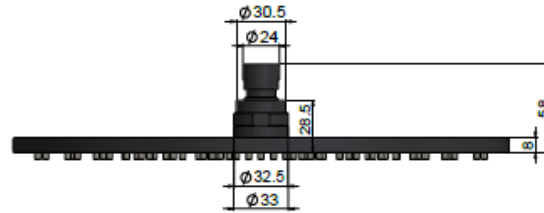

FLOW RATE GRAPH

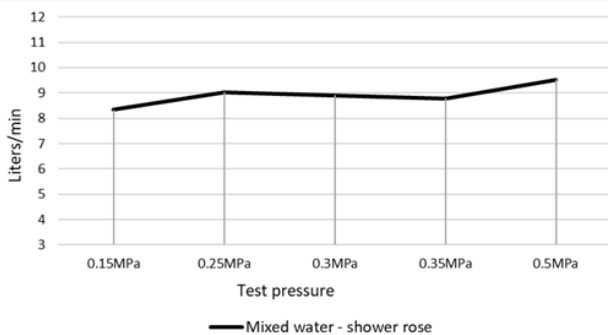

CREDENTIALS

- Watermark AS/NZS3718WMKA25013
- Wels Rated 3 Star

EXPLODED VIEW

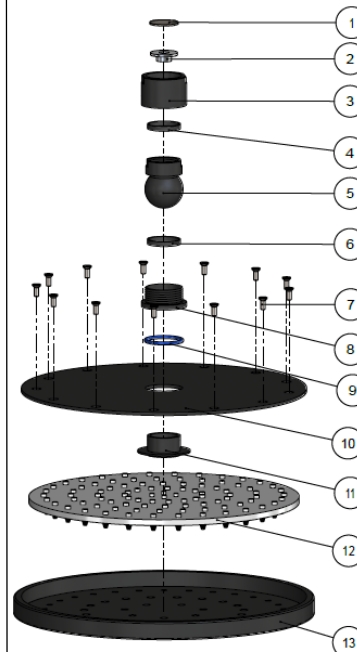

No.	Part Name
1	Strainer
2	Flow Controller
3	Nut
4	Wearing Ring
5	Universal Ball
6	Wearing Ring
7	Screw
8	Connet Nut
9	O-ring
10	Cover Plate
11	Connector
12	Rubber Gasket
13	Plate