

nood co.™
CONCRETE FURNITURE



Wall Hung.

20 — 21 BASIN RANGE

*21 sink designs, 14 colours.
Rethought for accessible living.*

TABLE OF CONTENTS



PICTURED: SHELF 01 BASIN | SKY GREY

ROUND BASINS	PAGE NO.
Prism Basin, Circle	08
Stepp Basin, Circle	10
Bowl Basin	12
Funl Basin	14
Tubb Basin	16
Hoop Basin	18
Bowl Basin, Two Tone	20
SQUARE BASINS	PAGE NO.
Cube Basin	22
Vesl Basin, Square	24
Herbert Basin	26
OVAL BASINS	PAGE NO.
Pill Basin	28
RECTANGLE BASINS	PAGE NO.
Prism Basin, Rectangle	30
Stepp Basin, Rectangle	32
Vesl Basin, Rectangle	34
Box Basin	36
Box Basin, Two Tone	38
Trough Basin	40
OVERFLOW BASINS	PAGE NO.
Shelf O1 Basin	42
Shelf O2 Basin	44
Shelf O3 Basin	46
Shelf Oval Basin	48
ADDITIONAL INFO	PAGE NO.
Assembly (Timber Frame Wall)	49
Assembly (Masonry Wall)	50
Colour Range	51
Concrete, a true picture	51
Maintenance	52
Packaging and Transport	53
Nood Co Concrete Composition	53
Meet The Team	54

PICTURED: BOX BASIN TWO TONE | MID TONE GREY





PICTURED: STEPP CIRCLE TWO TONE | MID TONE GREY



for the mimimal, for the accessible

For narrow spaces, minimal aesthetics or just the design-savvy, the Nood Co wall hung series is your solution. With a stunning offering of 20 wall hung basin designs, each basin featuring its own unique wall mount bracket. Concrete has never looked so good.

With design profiles ranging from circle, square, oval, rectangle, trough and much more this glorious range of UHP concrete offer an unrivalled real world performance and simple install.

Available in pastel concrete, in 14 colours.

A new consciousness in concrete is here.



IVORY



SAND



CUSTARD



PASTEL PEACH



BLUSH PINK



MUSK

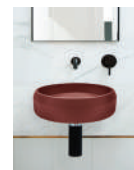

CLAY

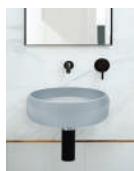

POWDER BLUE

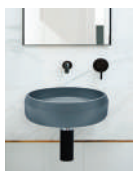

COPAN BLUE

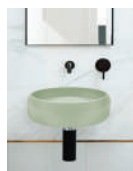

MINT

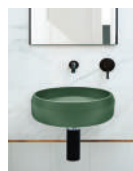

TEAL



SKY GREY



MID TONE GREY



CHARCOAL

ROUND

Prism Basin, Circle



Details

A favourite at Nood Co, the alluring Prism Basin is a concrete sink featuring an elegant chamfered edge with a breathtaking high strength finish.

DIMENSIONS

BASIN	D400mm x H115mm* (D15.7in x H4.5in)*
EDGE	Chamfer L40mm (1.5in)* Side Wall L70mm (2.7in)*

WEIGHT

BASIN	10kg (22lb)*
-------	--------------

WASTE REQUIRED

Suits standard 32mm (1¼in)

THICKNESS

BASIN WALL	10mm (0.39in)
------------	---------------

SEALER

Nood Co Deep Seal System

ASSEMBLY

Important Note: Please install bracket direct to masonry or timber wall, prior to sheeting and tiling.

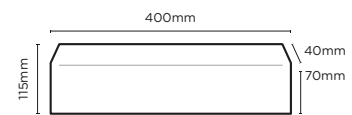
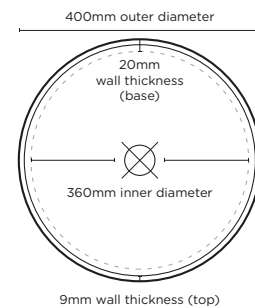

* Measurements and weights are approximate.
Waste not provided by Nood Co. Colours may vary.
Warranty / Packaging / Maintenance / Assembly Instructions
can be found at rear of catalogue.



IVORY



SAND



CUSTARD



PASTEL PEACH



BLUSH PINK



MUSK



CLAY



POWDER BLUE



COPAN BLUE

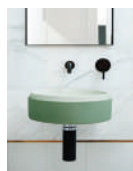

MINT



TEAL



SKY GREY



MID TONE GREY



CHARCOAL

ROUND

Stepp Basin, Circle



Details

The Stepp Basin in Circle is a designer's dream. A two-toned palette and elegant curves create a high-end, contemporary masterpiece with this concrete sink.

DIMENSIONS

BASIN D400mm x H115mm*
(D15.7in x H4.5in)*

WEIGHT

BASIN 10kg (22lb)*

WASTE REQUIRED

Suits standard 32mm (1¼in)

THICKNESS

BASIN WALL 10mm top (0.39in), 20mm base (0.78in)

SEALER

Nood Co Deep Seal System

ASSEMBLY

Important Note: Please install bracket direct to masonry or timber wall, prior to sheeting and tiling.

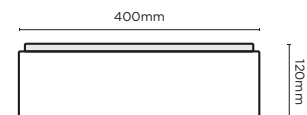
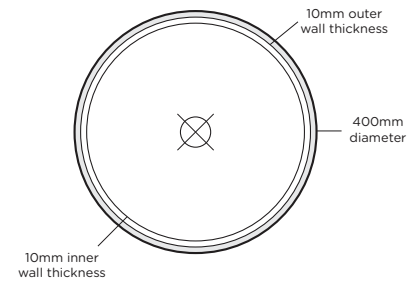

* Measurements and weights are approximate.
Waste not provided by Nood Co. Colours may vary.
Warranty / Packaging / Maintenance / Assembly Instructions
can be found at rear of catalogue.



IVORY



SAND



CUSTARD



PASTEL PEACH



BLUSH PINK



MUSK



CLAY

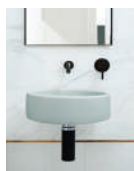

POWDER BLUE

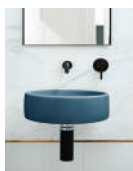

COPAN BLUE

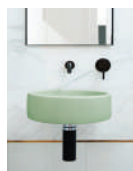

MINT

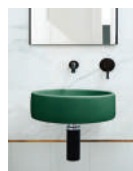

TEAL



SKY GREY



MID TONE GREY

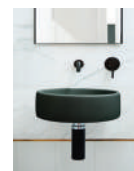

CHARCOAL

ROUND

Bowl Basin



Details

The Bowl Basin is feminine and refined. Dainty curves and soft pastels fuse together as this modest sink heroes your bathroom.

DIMENSIONS

BASIN D400mm x H115mm*
(D15.7in x H4.5in)*

WEIGHT

BASIN 10kg (22lb)*

WASTE REQUIRED

Suits standard 32mm (1¼in)

THICKNESS

BASIN WALL 20mm (0.78in)

SEALER

Nood Co Deep Seal System

ASSEMBLY

Important Note: Please install bracket direct to masonry or timber wall, prior to sheeting and tiling.

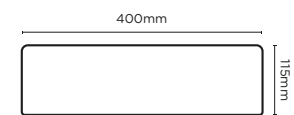
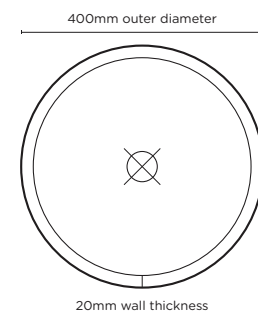

* Measurements and weights are approximate. Waste not provided by Nood Co. Colours may vary. Warranty / Packaging / Maintenance / Assembly Instructions can be found at rear of catalogue.



IVORY

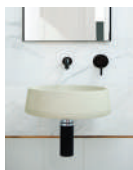

SAND



CUSTARD



PASTEL PEACH



BLUSH PINK



MUSK



CLAY

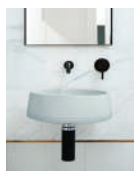

POWDER BLUE

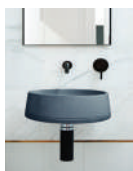

COPAN BLUE

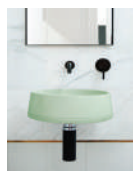

MINT

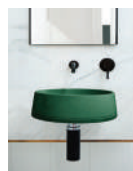

TEAL



SKY GREY



MID TONE GREY

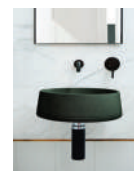

CHARCOAL

ROUND

Funl Basin



Details

The Funl concrete basin has gorgeous angled walls that funnel down to a squared base to create an elegant bathroom masterpiece.

DIMENSIONS

BASIN Base D400mm, Top D355mm, H115mm
(Base D15.7in, Top D13.9in, H4.5in)*

WEIGHT

BASIN 10kg (22lb)*

WASTE REQUIRED

Suits standard 32mm (1¼in)

THICKNESS

BASIN WALL 10mm (0.39in)

SEALER

Nood Co Deep Seal System

ASSEMBLY

Important Note: Please install bracket direct to masonry or timber wall, prior to sheeting and tiling.

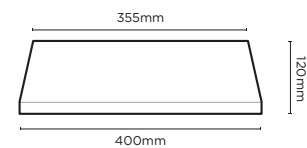
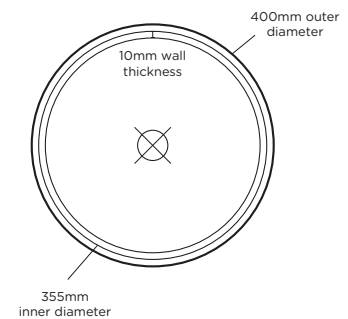

* Measurements and weights are approximate.
Waste not provided by Nood Co. Colours may vary.
Warranty / Packaging / Maintenance / Assembly Instructions
can be found at rear of catalogue.



IVORY



SAND



CUSTARD



PASTEL PEACH



BLUSH PINK



MUSK



CLAY

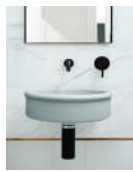

POWDER BLUE



COPAN BLUE

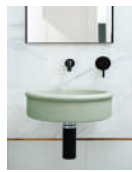

MINT



TEAL



SKY GREY



MID TONE GREY



CHARCOAL

ROUND

Tubb Basin



Details

Cute and podgy, the curvy Tubb Basin features a bathtub style rim and the modernistic charm of the 1950s. A design for the true creatives.

DIMENSIONS

BASIN Internal D360mm (D14.1in)*
External D420mm (D16.5in)*
H115mm (H4.5in)*

WEIGHT

BASIN 10kg (22lb)*

WASTE REQUIRED

Suits standard 32mm (1¼in)

THICKNESS

BASIN WALL 25mm (0.98in)

SEALER

Nood Co Deep Seal System

ASSEMBLY

Important Note: Please install bracket direct to masonry or timber wall, prior to sheeting and tiling.

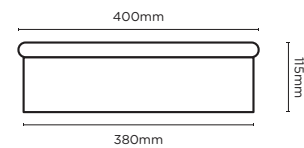
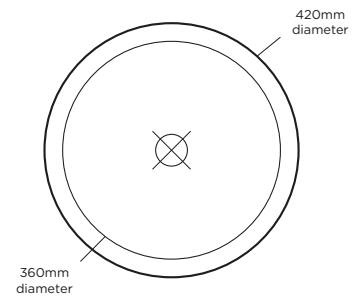

* Measurements and weights are approximate.
Waste not provided by Nood Co. Colours may vary.
Warranty / Packaging / Maintenance / Assembly Instructions
can be found at rear of catalogue.



IVORY



SAND



CUSTARD



PASTEL PEACH



BLUSH PINK



MUSK



CLAY

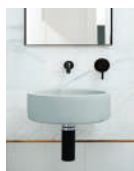

POWDER BLUE

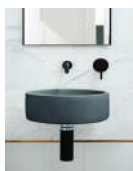

COPAN BLUE

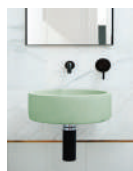

MINT



TEAL



SKY GREY



MID TONE GREY



CHARCOAL

ROUND

Hoop Basin



Details

With its sleek walls and clean-cut edges, the concrete Hoop Basin by Nood Co adds a refined touch to the bathroom.

DIMENSIONS

BASIN D400mm x H115mm
(D15.7in x H4.5in)*

WEIGHT

BASIN 10kg (22lb)*

WASTE REQUIRED

Suits standard 32mm (1¼in)

THICKNESS

BASIN WALL 20mm (0.78in)

SEALER

Nood Co Deep Seal System

ASSEMBLY

Important Note: Please install bracket direct to masonry or timber wall, prior to sheeting and tiling.

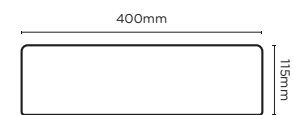
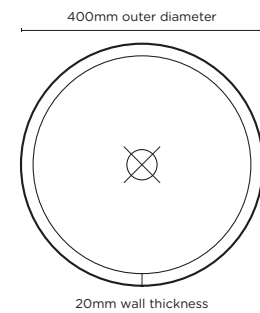

* Measurements and weights are approximate.
Waste not provided by Nood Co. Colours may vary.
Warranty / Packaging / Maintenance / Assembly Instructions
can be found at rear of catalogue.



IVORY



SAND



CUSTARD



PASTEL PEACH



BLUSH PINK



MUSK



CLAY

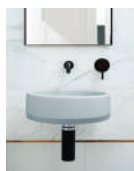

POWDER BLUE

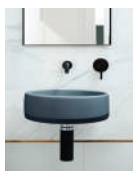

COPAN BLUE

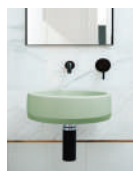

MINT



TEAL



SKY GREY



MID TONE GREY



CHARCOAL

ROUND

Bowl Basin, Two Tone

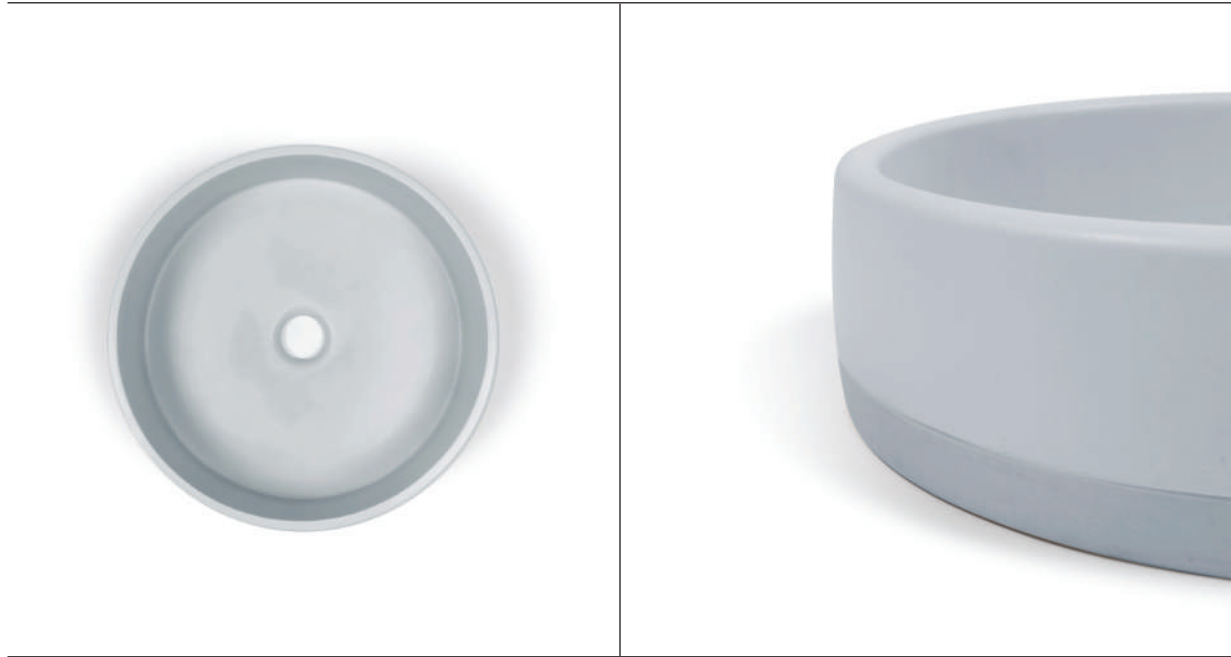

Details

The Bowl Basin is back with a stunning new outfit. Two tones add a dynamic to your bathroom space like never before seen.

DIMENSIONS

BASIN D400mm x H115mm
(D15.7in x H4.5in)*

TWO TONE 30mm (1.18in) from bottom edge

WEIGHT

BASIN 10kg (22lb)*

WASTE REQUIRED

Suits standard 32mm (1¼in)

THICKNESS

BASIN WALL 20mm (0.78in)

SEALER

Nood Co Deep Seal System

ASSEMBLY

Important Note: Please install bracket direct to masonry or timber wall, prior to sheeting and tiling.

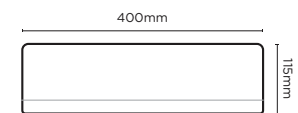
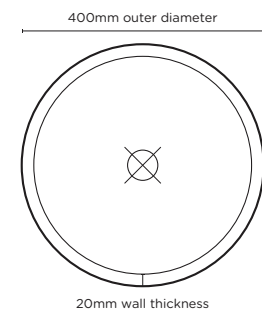

* Measurements and weights are approximate.
Waste not provided by Nood Co. Colours may vary.
Warranty / Packaging / Maintenance / Assembly Instructions
can be found at rear of catalogue.



IVORY



SAND



CUSTARD



PASTEL PEACH



BLUSH PINK



MUSK



CLAY

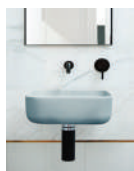

POWDER BLUE

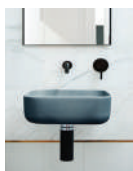

COPAN BLUE

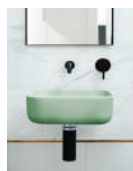

MINT



TEAL



SKY GREY



MID TONE GREY

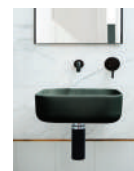

CHARCOAL

SQUARE

Cube Basin



Details

Offsetting symmetry with smooth, rounded corners, the concrete Cube Basin by Nood Co is the perfect addition to any bathroom space.

DIMENSIONS

BASIN TOP L390mm x W390mm x H115mm

(L15.3in x W15.3in x H4.5in)*

BASIN BASE L350mm x W350mm

(L13.7in x W13.7in)*

WEIGHT

BASIN 8.6kg (19lb)*

WASTE REQUIRED

Suits standard 32mm (1¼in)

THICKNESS

BASIN WALL 12mm (0.47in)

SEALER

Nood Co Deep Seal System

ASSEMBLY

Important Note: Please install bracket direct to masonry or timber wall, prior to sheeting and tiling.

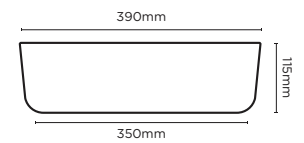
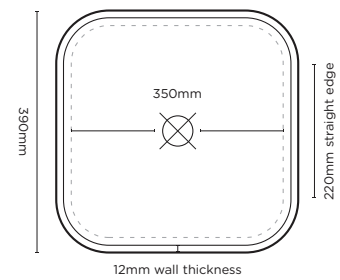

* Measurements and weights are approximate.
Waste not provided by Nood Co. Colours may vary.
Warranty / Packaging / Maintenance / Assembly Instructions
can be found at rear of catalogue.



IVORY



SAND



CUSTARD



PASTEL PEACH



BLUSH PINK



MUSK



CLAY

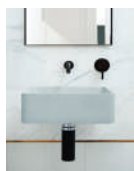

POWDER BLUE

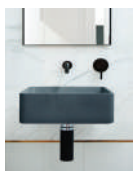

COPAN BLUE



MINT



TEAL



SKY GREY



MID TONE GREY

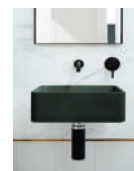

CHARCOAL

SQUARE

Vesl Basin, Square



Details

The Vesl Square concrete basin is the perfect contemporary solution. Smooth, curved corners and ultra fine concrete elevate the space with style.

DIMENSIONS

BASIN L400mm x W400mm x H115mm
(L15.7in x W15.7in x H4.5in)*

WEIGHT

BASIN 10kg (22lb)*

WASTE REQUIRED

Suits standard 32mm (1¼in)

THICKNESS

BASIN WALL 15mm (0.59in)

SEALER

Nood Co Deep Seal System

ASSEMBLY

Important Note: Please install bracket direct to masonry or timber wall, prior to sheeting and tiling.

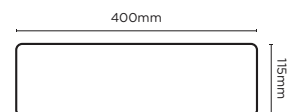
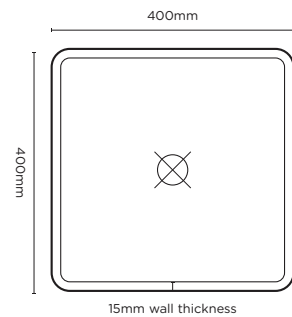

* Measurements and weights are approximate.
Waste not provided by Nood Co. Colours may vary.
Warranty / Packaging / Maintenance / Assembly Instructions
can be found at rear of catalogue.



IVORY



SAND



CUSTARD



PASTEL PEACH



BLUSH PINK



MUSK



CLAY



POWDER BLUE



COPAN BLUE



MINT



TEAL



SKY GREY



MID TONE GREY



CHARCOAL

SQUARE

Herbert Basin



Details

Herbert is the perfect presentation piece, for your commercial or residential space. Featuring a narrow 355mm depth for tight spaces, this basin can sit on a vanity or wall hang.

DIMENSIONS

BASIN	L410 x W355mm x H335mm (L16.2in x W13.1in x H13.1in)*
BASIN HEIGHT	125mm (4.9in)*
STRIP	W400mm x H87mm (W15.7in x H3.4in)*

WEIGHT

BASIN	14.1kg (30.9lb)
-------	-----------------

WASTE REQUIRED

Suits standard 32mm (1¼in)

THICKNESS

BASIN WALL	20mm (0.78in)	STRIP	10mm (0.39in)
SPLASHBACK	20mm (0.78in)		

SEALER

Nood Co Deep Seal System

TAP

150mm tap required. Holes to be cut by Nood.

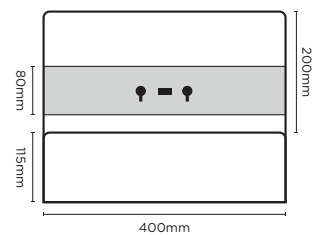
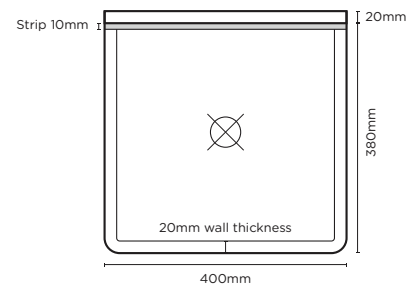

* Measurements and weights are approximate.
Waste not provided by Nood Co. Colours may vary.
Warranty / Packaging / Maintenance / Assembly Instructions
can be found at rear of catalogue.

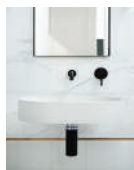

IVORY

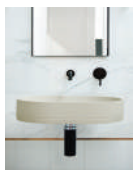

SAND

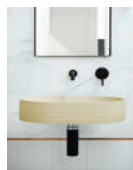

CUSTARD



PASTEL PEACH



BLUSH PINK



MUSK



CLAY



POWDER BLUE

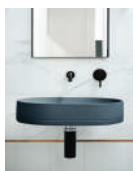

COPAN BLUE



MINT



TEAL



SKY GREY



MID TONE GREY



CHARCOAL

OVAL

Pill Basin

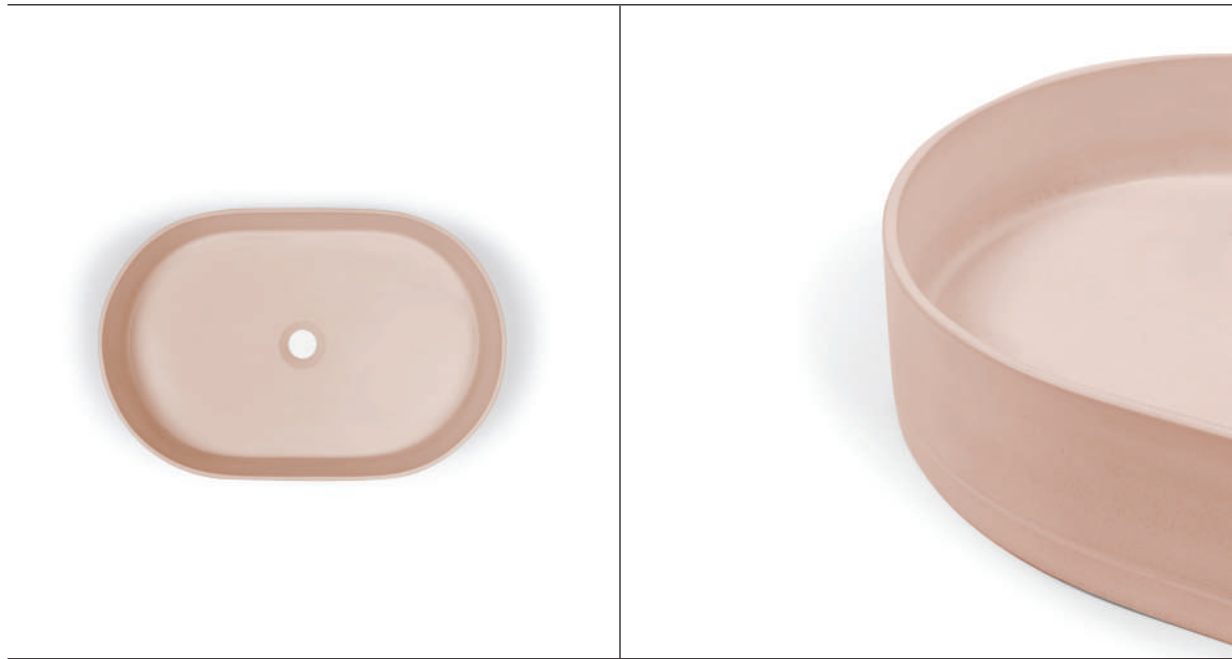

Details

The Pill Basin is the perfect designer finish for the modern bathroom. With sleek rounded edges and ultra fine concrete walls, this contemporary concrete sink is the showpiece to elevate your space.

DIMENSIONS

BASIN L580mm x W380mm x H100mm*
(L22.8in x W14.9in x H3.9in)*

WEIGHT

BASIN 11kg (24lb)*

WASTE REQUIRED

Suits standard 32mm (1¼in)

THICKNESS

BASIN WALL 12mm (0.47in)

SEALER

Nood Co Deep Seal System

ASSEMBLY

Important Note: Please install bracket direct to masonry or timber wall, prior to sheeting and tiling.

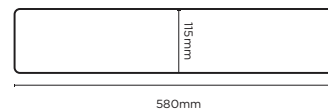
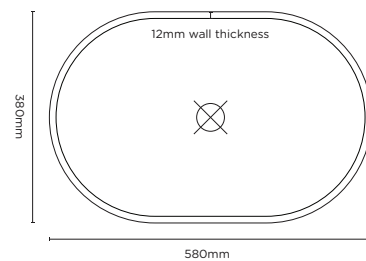

* Measurements and weights are approximate.
Waste not provided by Nood Co. Colours may vary.
Warranty / Packaging / Maintenance / Assembly Instructions
can be found at rear of catalogue.



IVORY

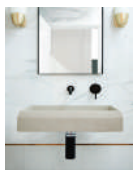

SAND



CUSTARD



PASTEL PEACH



BLUSH PINK



MUSK



CLAY



POWDER BLUE



COPAN BLUE



MINT



TEAL



SKY GREY



MID TONE GREY



CHARCOAL

RECTANGLE

Prism Basin, Rectangle



Details

A favourite at Nood Co, the alluring Prism Basin is a concrete sink featuring an elegant chamfered edge with a breathtaking high strength finish.

DIMENSIONS

BASIN L600mm x W400mm x H115mm*
(L23.6in x W15.7in x H4.5in)*

EDGE Chamfer L40mm (1.5in)*
Side Wall L70mm (2.7in)*

WEIGHT

BASIN 16kg (35lb)*

WASTE REQUIRED

Suits standard 32mm (1¼in)

THICKNESS

BASIN WALL 9mm (0.35in) top
20mm (0.78in) base

SEALER

Nood Co Deep Seal System

ASSEMBLY

Important Note: Please install bracket direct to masonry or timber wall, prior to sheeting and tiling.

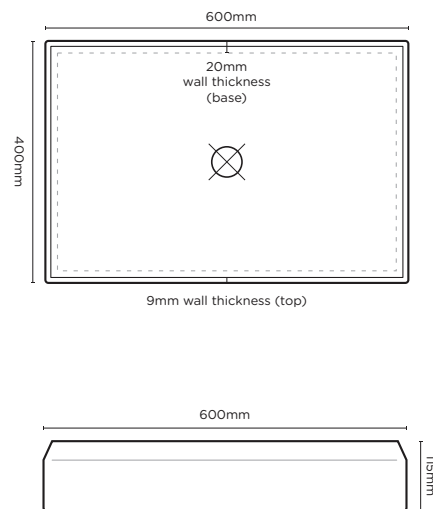

* Measurements and weights are approximate.
Waste not provided by Nood Co. Colours may vary.
Warranty / Packaging / Maintenance / Assembly Instructions
can be found at rear of catalogue.

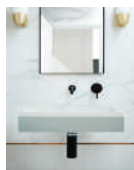

IVORY

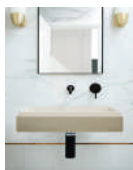

SAND



CUSTARD



PASTEL PEACH



BLUSH PINK



MUSK



CLAY

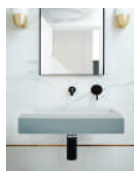

POWDER BLUE

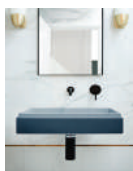

COPAN BLUE



MINT



TEAL



SKY GREY



MID TONE GREY



CHARCOAL

Stepp Basin, Rectangle

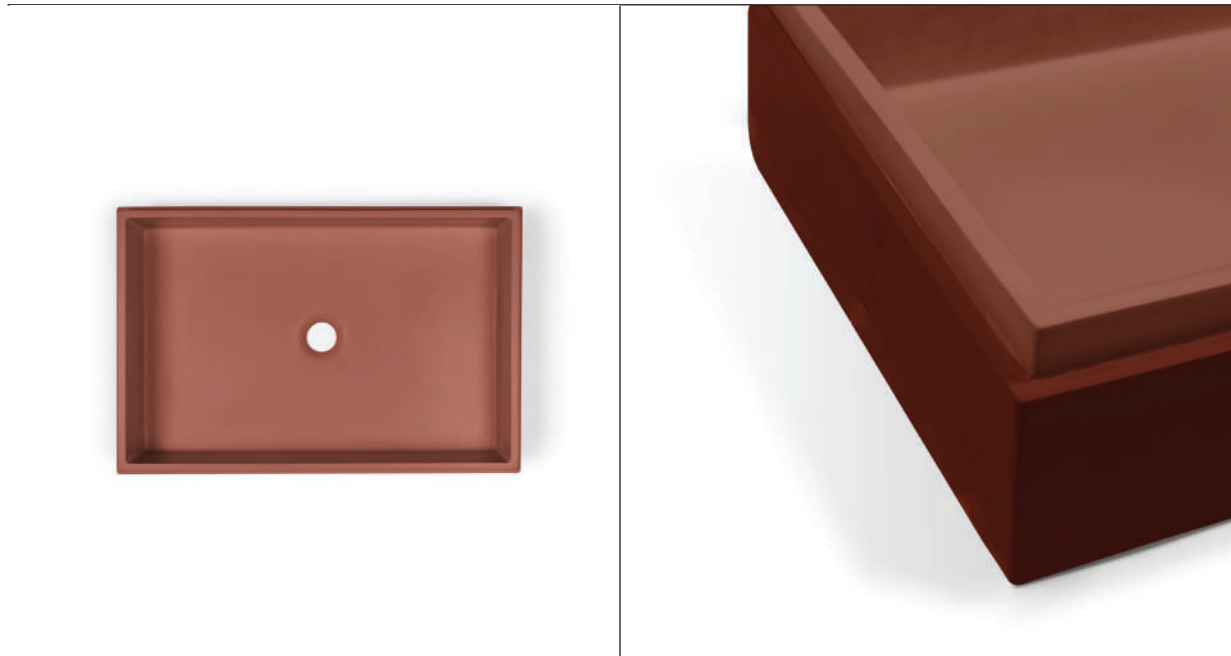

Details

The Stepp Basin changes the perception of concrete sink design. Two toned colours and refined edges create a high-end, contemporary offering for bathrooms.

DIMENSIONS

BASIN L600mm x W400mm x H115mm*
(L23.6in x W15.7in x H4.5in)*

WEIGHT

BASIN 16kg (35lb)*

WASTE REQUIRED

Suits standard 32mm (1¼in)

THICKNESS

BASIN WALL 10mm (0.39in) top
20mm (0.78in) base

SEALER

Nood Co Deep Seal System

ASSEMBLY

Important Note: Please install bracket direct to masonry or timber wall, prior to sheeting and tiling.

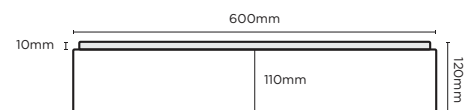
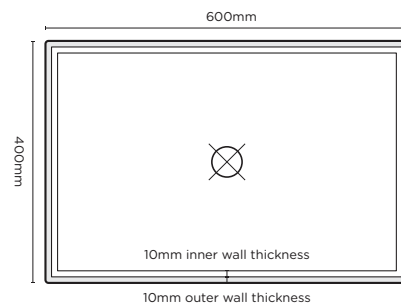

* Measurements and weights are approximate.
Waste not provided by Nood Co. Colours may vary.
Warranty / Packaging / Maintenance / Assembly Instructions
can be found at rear of catalogue.

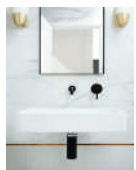

IVORY

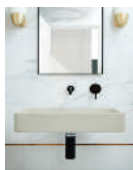

SAND



CUSTARD



PASTEL PEACH



BLUSH PINK



MUSK



CLAY

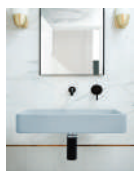

POWDER BLUE

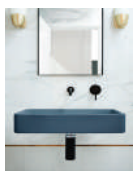

COPAN BLUE



MINT

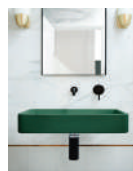

TEAL



SKY GREY



MID TONE GREY



CHARCOAL

RECTANGLE

Vesl Basin, Rectangle



Details

With contemporary curves and refined edges, the Vesl Rectangle ushers in a new standard in high strength concrete basins for designers to engage.

DIMENSIONS

BASIN L600mm x W400mm x H115mm*
(L23.6in x W15.7in x H4.5in)*

WEIGHT

BASIN 16kg (35lb)*

WASTE REQUIRED

Suits standard 32mm (1¼in)

THICKNESS

BASIN WALL 15mm (0.59in)

SEALER

Nood Co Deep Seal System

ASSEMBLY

Important Note: Please install bracket direct to masonry or timber wall, prior to sheeting and tiling.

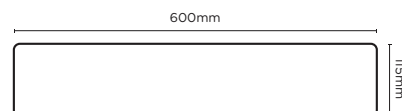
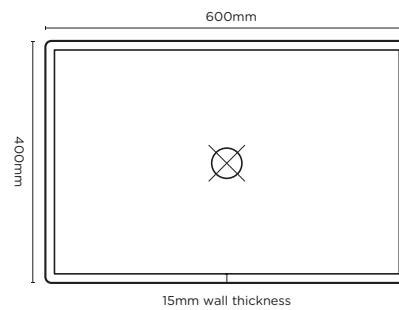

* Measurements and weights are approximate.
Waste not provided by Nood Co. Colours may vary.
Warranty / Packaging / Maintenance / Assembly Instructions
can be found at rear of catalogue.

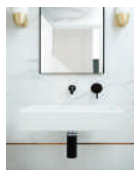

IVORY

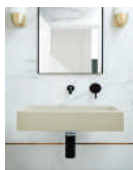

SAND

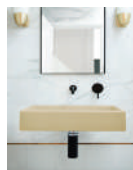

CUSTARD



PASTEL PEACH



BLUSH PINK



MUSK



CLAY



POWDER BLUE

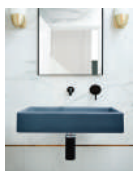

COPAN BLUE

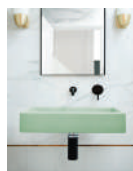

MINT



TEAL



SKY GREY



MID TONE GREY



CHARCOAL

RECTANGLE

Box Basin



Details

Add form and shape to your aesthetic and pastel to your palette. The structured form of the Box Basin sits beautifully on surface tops throughout your home.

DIMENSIONS

BASIN L595mm x W395mm x H115mm*
(L23.4in x W15.5in x H4.5in)*

WEIGHT

BASIN 16kg (35lb)*

WASTE REQUIRED

Suits standard 32mm (1¼in)

THICKNESS

BASIN WALL 20mm (0.78in)

SEALER

Nood Co Deep Seal System

ASSEMBLY

Important Note: Please install bracket direct to masonry or timber wall, prior to sheeting and tiling.

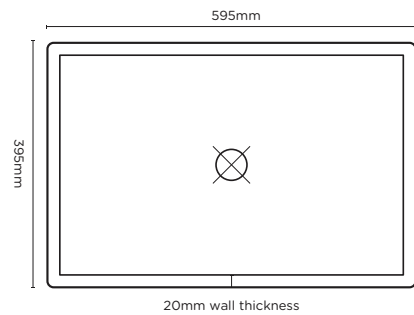

* Measurements and weights are approximate.
Waste not provided by Nood Co. Colours may vary.
Warranty / Packaging / Maintenance / Assembly Instructions
can be found at rear of catalogue.

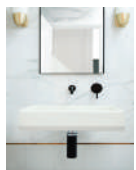

IVORY

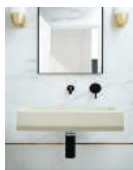

SAND

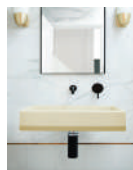

CUSTARD



PASTEL PEACH



BLUSH PINK

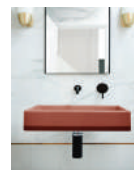

MUSK



CLAY

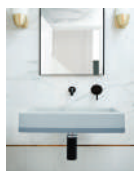

POWDER BLUE

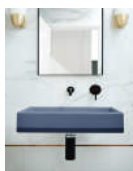

COPAN BLUE

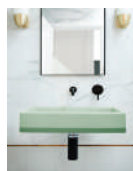

MINT



TEAL



SKY GREY



MID TONE GREY



CHARCOAL

RECTANGLE

Box Basin, Two Tone



Details

The Box Basin got himself a makeover. Now in gorgeous two tones, prepare to re-think the level of detail possible in your bathroom space.

DIMENSIONS

BASIN L595mm x W395mm x H115mm*
(L23.4in x W15.5in x H4.5in)*
TWO TONE H30mm (H1.2in) from bottom*

WEIGHT

BASIN 16kg (35lb)*

WASTE REQUIRED

Suits standard 32mm (1¼in)

THICKNESS

BASIN WALL 20mm (0.78in)

SEALER

Nood Co Deep Seal System

ASSEMBLY

Important Note: Please install bracket direct to masonry or timber wall, prior to sheeting and tiling.

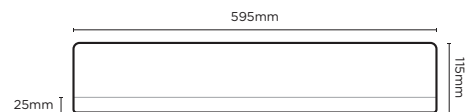
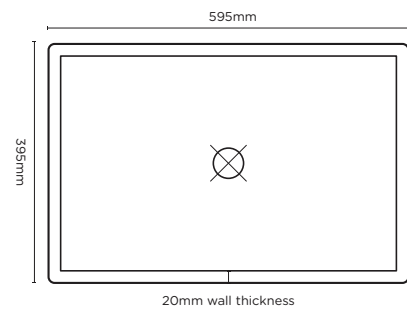

* Measurements and weights are approximate.
Waste not provided by Nood Co. Colours may vary.
Warranty / Packaging / Maintenance / Assembly Instructions
can be found at rear of catalogue.



IVORY



SAND



CUSTARD



PASTEL PEACH



BLUSH PINK



MUSK



CLAY



POWDER BLUE



COPAN BLUE



MINT



TEAL



SKY GREY



MID TONE GREY



CHARCOAL

RECTANGLE

Trough Basin



Details

The high strength concrete Trough Basin is sculptural and silky smooth. Nostalgic in its reference and contemporary in presentation.

DIMENSIONS

BASIN L875mm x W415mm x H165mm*
(L34.4in x W16.3in x H6.5in)*

WEIGHT

BASIN 50kg (110lb)*

WASTE REQUIRED

Suits standard 40mm (1.57in)

THICKNESS

BASIN WALL 20mm (0.78in)

SEALER

Nood Co Deep Seal System

ASSEMBLY

Important Note: Please install bracket direct to masonry or timber wall, prior to sheeting and tiling.

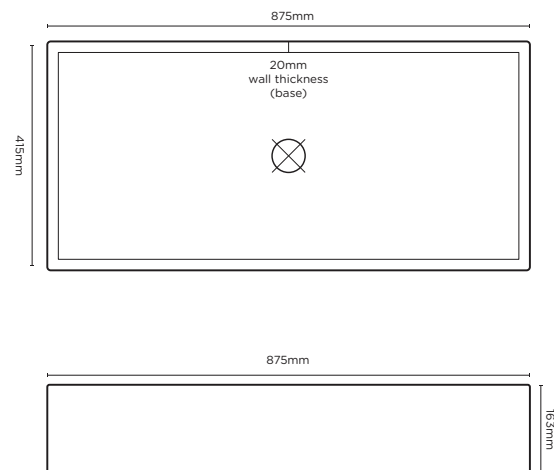

* Measurements and weights are approximate.
Waste not provided by Nood Co. Colours may vary.
Warranty / Packaging / Maintenance / Assembly Instructions
can be found at rear of catalogue.



IVORY



SAND



CUSTARD



PASTEL PEACH



BLUSH PINK



MUSK



CLAY

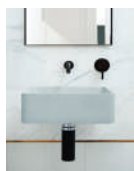

POWDER BLUE

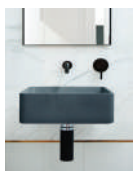

COPAN BLUE



MINT



TEAL



SKY GREY



MID TONE GREY

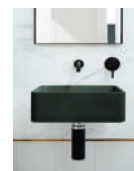

CHARCOAL

OVERFLOW

Shelf O1 Basin



Details

The versatile Shelf O1 is perfect for powder rooms, tight spaces, high rise builds, minimal environments. Boasting a 440mm x 250mm x 130mm dimension, overflow kit, wall-hang capacity, and handy shelf for optional tap.

DIMENSIONS

- BASIN L440mm x W250mm x H130mm
(L17.3in x W9.8in x H5.1in)*
- OVERFLOW W100mm (W3.9in)*
- LEDGE 15mm (0.5in) step down

WEIGHT

- BASIN 8.6kg (18.95lb)

WASTE REQUIRED

Suits standard 32mm (1¼in)

THICKNESS

- BASIN WALL 20mm (0.78in)

SEALER

Nood Co Deep Seal System

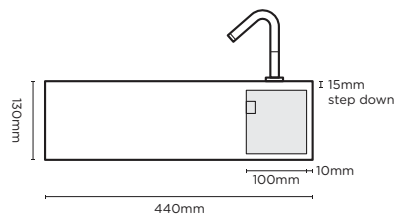
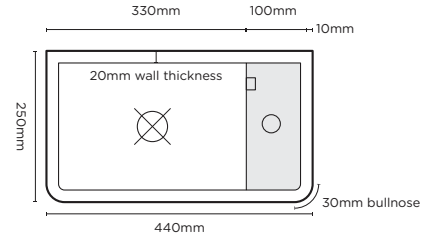

* Measurements and weights are approximate. Waste not provided by Nood Co. Colours may vary. Warranty / Packaging / Maintenance / Assembly Instructions can be found at rear of catalogue.

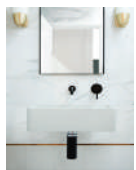

IVORY

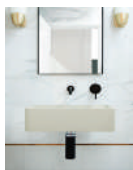

SAND

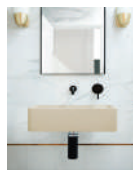

CUSTARD



PASTEL PEACH



BLUSH PINK



MUSK



CLAY



POWDER BLUE

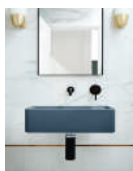

COPAN BLUE

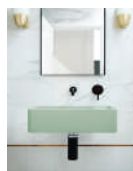

MINT



TEAL



SKY GREY



MID TONE GREY



CHARCOAL

OVERFLOW

Shelf O2 Basin



Details

The Shelf O2 is perfect for powder rooms, tight spaces, high-rise builds and minimal environments. Boasting a 540mm x 300mm x 130mm dimension, overflow kit, wall hang capacity, and handy shelf for optional tap.

DIMENSIONS

BASIN L600mm x W400mm x H130mm
(L23.6in x W15.7in x H5.1in)*

OVERFLOW W100mm (W3.9in)*

LEDGE 15mm (0.5in) step down

WEIGHT

BASIN 11.35kg (25lb)*

WASTE REQUIRED

Suits standard 32mm (1¼in)

THICKNESS

BASIN WALL 20mm (0.78in)

SEALER

Nood Co Deep Seal System

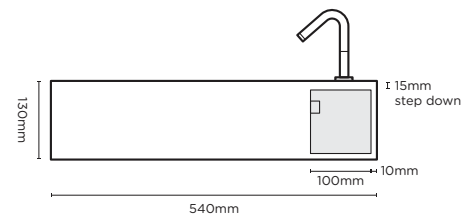
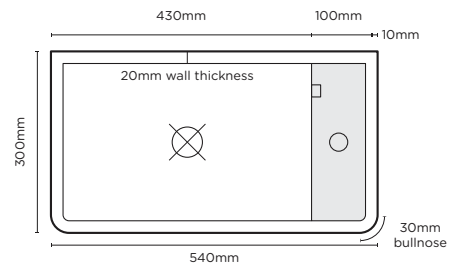

* Measurements and weights are approximate.
Waste not provided by Nood Co. Colours may vary.
Warranty / Packaging / Maintenance / Assembly Instructions
can be found at rear of catalogue.

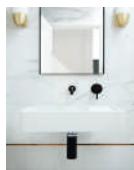

IVORY

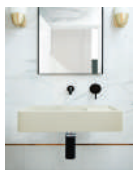

SAND



CUSTARD



PASTEL PEACH



BLUSH PINK



MUSK



CLAY



POWDER BLUE

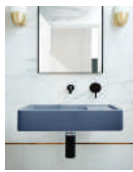

COPAN BLUE



MINT



TEAL



SKY GREY



MID TONE GREY



CHARCOAL

OVERFLOW

Shelf O3 Basin



Details

The Shelf O3 is perfect for powder rooms, high rise builds and minimal environments. Boasting a 640mm x 400mm x 130mm dimension, overflow kit, wall hang capacity, and handy shelf for optional tap.

DIMENSIONS

BASIN	L540mm x W300mm x H130mm (L21.2in x W11.8in x H5.1in)*
OVERFLOW	W100mm (W3.9in)*
LEDGE	15mm (0.5in) step down

WEIGHT

BASIN	16.55kg (36.4lb)*
-------	-------------------

WASTE REQUIRED

Suits standard 32mm (1¼in)

THICKNESS

BASIN WALL	20mm (0.78in)
------------	---------------

SEALER

Nood Co Deep Seal System

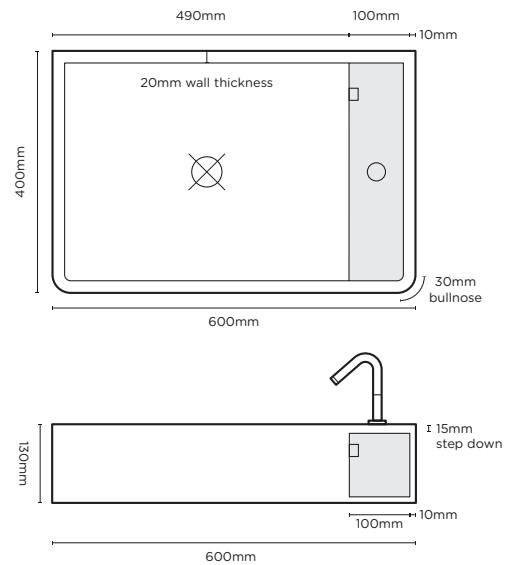

* Measurements and weights are approximate.
Waste not provided by Nood Co. Colours may vary.
Warranty / Packaging / Maintenance / Assembly Instructions
can be found at rear of catalogue.

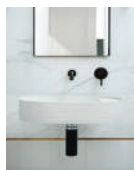

IVORY



SAND

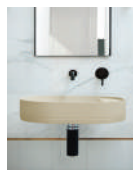

CUSTARD



PASTEL PEACH



BLUSH PINK



MUSK



CLAY



POWDER BLUE



COPAN BLUE



MINT



TEAL



SKY GREY



MID TONE GREY



CHARCOAL

OVERFLOW

Shelf Oval Basin



Details

The Shelf Oval Basin is perfect for powder rooms, high rise builds and minimal environments. Boasting a 580mm x 380mm x 130mm dimension, overflow kit, wall hang capacity, and handy shelf for optional tap.

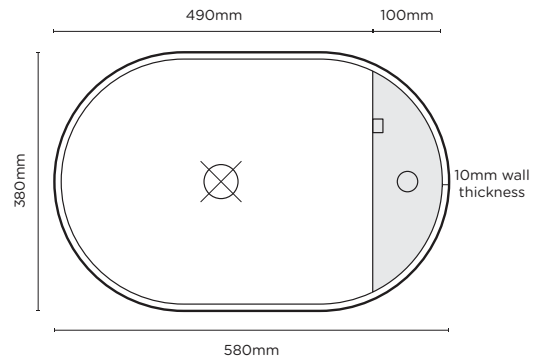

DIMENSIONS

BASIN L580mm x W380mm x H115mm
(L22.8in x W14.9in x H4.5in)*

OVERFLOW W100mm (W3.9in)*

LEDGE 15mm (0.5in) step down

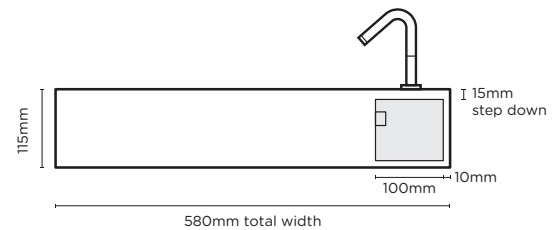

WEIGHT

BASIN 11.75kg (26lb)*

WASTE REQUIRED

Suits standard 32mm (1¼in)

THICKNESS

BASIN WALL 10mm (0.39in)

SEALER

Nood Co Deep Seal System

* Measurements and weights are approximate.
Waste not provided by Nood Co. Colours may vary.
Warranty / Packaging / Maintenance / Assembly Instructions
can be found at rear of catalogue.

Assembly (Timber Frame Wall)

STANDS

YOUR WALL MOUNT SINK KIT WILL CONTAIN:

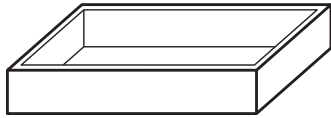

CONCRETE SINK X 1



SCREWS



GLUE

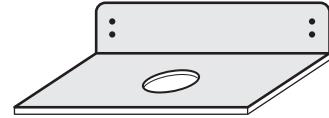

WALL MOUNT PLATE
(DESIGN VARIES PER SINK)

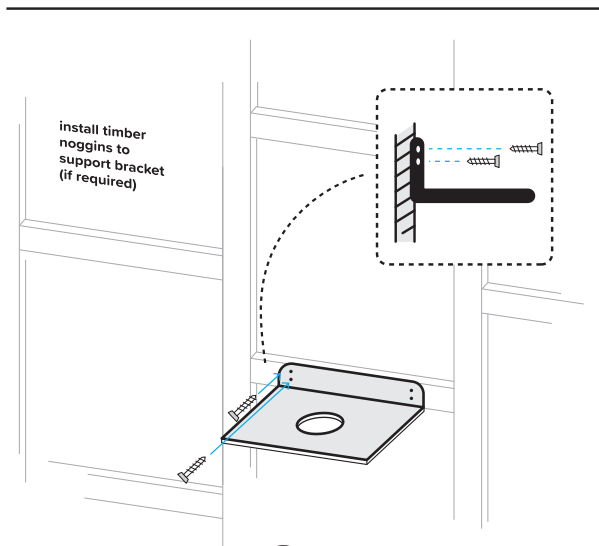

01

Screw bracket to timber frame noggins, bracket upright to sit flush with frame

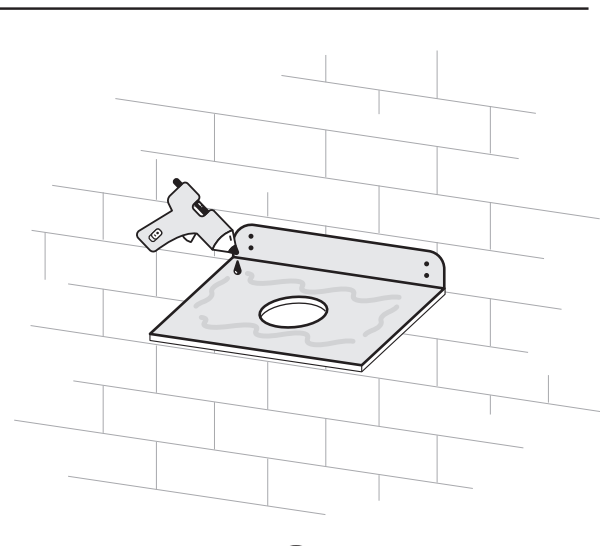

02

Sheet and tile over timber frame wall, then apply adhesive to bracket

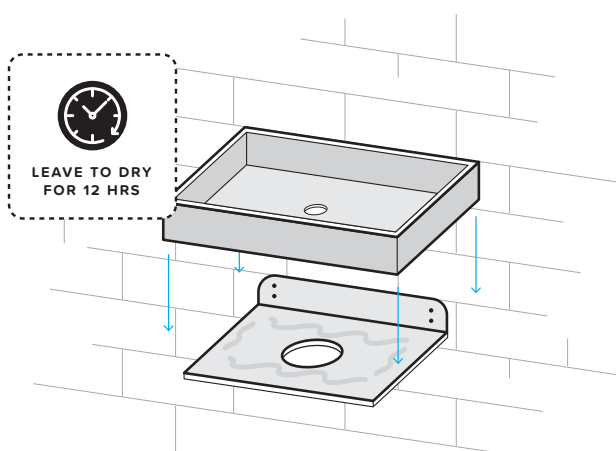

03

Lower basin onto glued brackets firmly, ensure basin is placed centrally

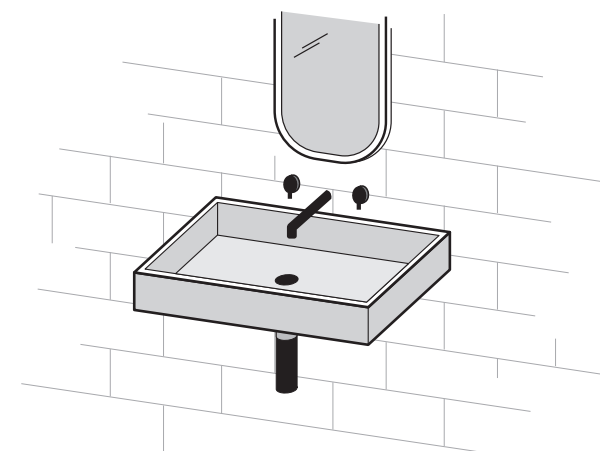

04

Allow glue to dry for 12 hours prior to installing plumbing fixtures. Enjoy.

Assembly (Masonry Wall)

STANDS

YOUR WALL MOUNT SINK KIT WILL CONTAIN:

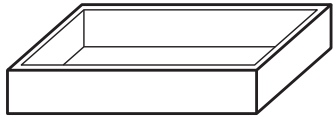

CONCRETE SINK X 1

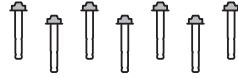

BOLTS



GLUE

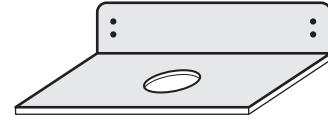

WALL MOUNT PLATE
(DESIGN VARIES PER SINK)

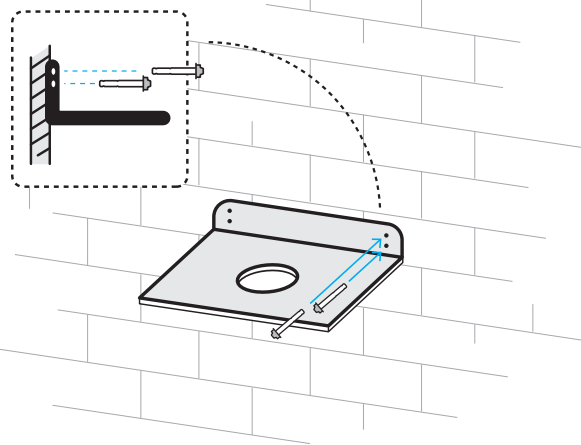

01

Bolt bracket to masonry wall, ensuring bracket is placed at level height

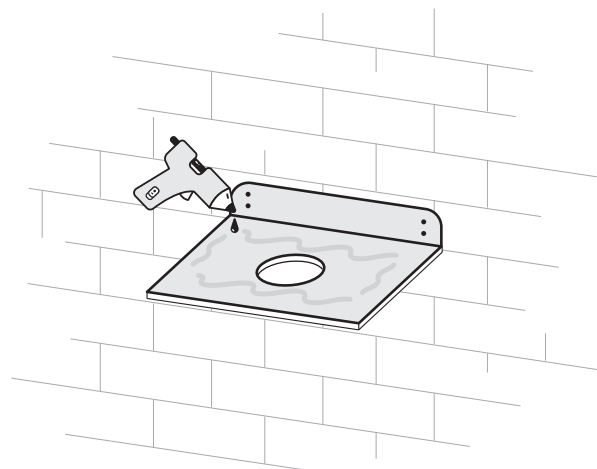

02

Render and tile wall, then apply adhesive to bracket

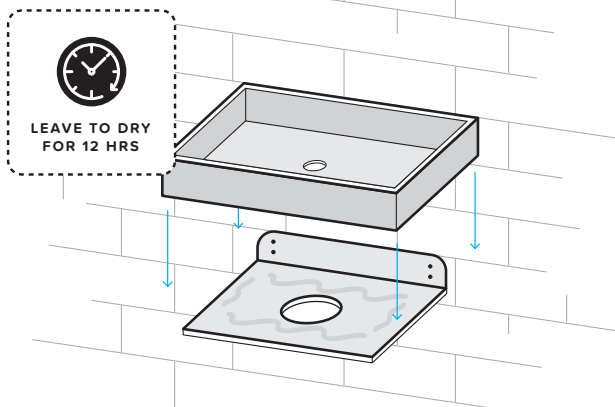

03

Lower basin onto glued brackets firmly, ensure basin is placed centrally

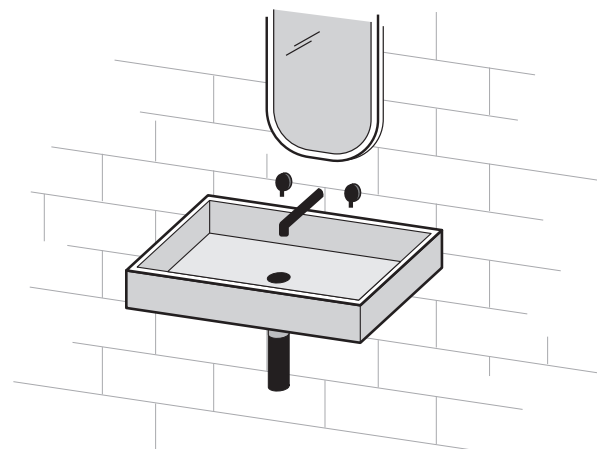

04

Allow glue to dry for 12 hours prior to installing plumbing fixtures. Enjoy.





wall bracket

A new standard in design consideration, the Nood Co wall bracket range offers a unique wall bracket design per basin. A big part of design is offering the client and trade a simple process of install, whilst never compromising on quality. This high-strength aluminium, powdercoated frame offers perfect support for its Nood basin. We have done the hard work so you can enjoy concrete in ways like never before.

A new consciousness in concrete is here.

Colour Range



Concrete, a true picture

Nood Co concrete basins are handmade with the finest concrete and have a high level of water tolerance and stain resistance. Here is a little more about what to expect from your concrete experience.

Concrete is a natural material and hence is subject to natural and human weathering. In response to this Nood Co have added special ingredients into its mix, and deep setting sealer to greatly improve how your basin performs, giving you a long-lasting experience.

For best long term results we suggest you:

- Use the wax provided. Generally you'll notice when the wax has worn away and then is a good time to reapply. Instructions on how to apply the wax are provided with each basin.
- Clean with a soft, microfibre cloth and soapy water. See maintenance for more.
- Clean as you spill. Stains are easily avoided by simply washing and wiping your spills as you go. For more please information see the maintenance section.
- Avoid leaving your basin plugged and filled with water for long periods of time.
- Closely follow the install instructions provided with each Nood package.



Concrete is a beautiful addition to your space, and well worth the small effort required to keep your space looking gorgeous.

For more please contact our friendly team at info@noodco.com.au.

Looking after your Nood basin is super simple, but everyone says that.

SO, WHAT CAN I REALISTICALLY EXPECT FROM MY NOOD BASIN EXPERIENCE?

Our concrete is sealed with a very effective, deep penetrating sealing system to allow a real-world function. With that said, Nood isn't ceramic. It's beautiful concrete and so we have some helpful tips to keep your basin even more beautiful for years to come.

CLEANING

Nood present the most advanced concrete composition on the market, we still encourage you to clean your spills as you go. Simply wash your spills away with soapy water and a soft, microfibre cloth. Please avoid scourers and strong cleaning chemicals.

Please immediately clean strong staining products such as coffee scrubs, acid-based products. Leaving these stains for over 6 hours although unlikely, may mark or etch the concrete.

For more information please check out our maintenance video at noodco.com.au.

SCRATCHING / CHIPS

Hey, it happens from time to time.

As your basin ages, it's likely that some minor scratching may have taken place. While this aligns with the natural beauty of concrete it may not always align with the client perception. Nood have colour repair kits ready to send out. They are simple to apply and will allow you to touch up any small imperfections on your basin.

For more information about repairs please email us at info@noodco.com.au.

WATER DROPS IN YOUR BASIN

Water drops are free to dry out in your basin. We've tested it, we've adjusted our concrete to it, and we've made sure this won't be an issue for you. 95% of water drops will dry into your concrete seamlessly. The other 5% will leave a white ring on your basin. In this rare case, simply wipe down with clean water and a microfibre cloth. Nice and easy.

WHAT'S THIS WAXING BUSINESS? SOUNDS LIKE WORK.

Not at all. Each Nood piece is carefully sealed and pre-waxed prior to delivery.

The basins are then packaged and sent out with spare maintenance wax and instructions so you can self-apply as necessary. The wax assists with abrasion and stain resistance. Simply apply more as you see it wear off. It's simple.

To view the wax application video please visit us at noodco.com.au.

HOW OFTEN DO I WAX?

Nood have tested it. The average frequency in which you'd need to reapply your wax, given you use your basin for 5 minutes and twice a day, is once every 3 months.

Nood have spare wax for when you require more, and we send out instructions on how to apply the wax with each basin. They are also available on our website.

To view the wax application video please visit us at noodco.com.au.

Packaging and Transport

Nood take the most care when it comes to packaging and transport. Each package is carefully wrapped in different grades of foam and boxed firmly with thick cardboard. Each package has flex points to allow for safe international and domestic travel.

Nood offer tracking with each package and a close access of communication. After all, this is your experience that we are excited to be a part of.

Nood Co Concrete Composition

Real beauty is on the inside.

The Nood concrete composition is a complex one. We won't bore you with too many details, but the Nood concrete is made of 8 highly refined components. Each component assists in a specific way, be it improving the concrete strength, the water ratio, mix integrity, water tolerance, colouring, durability and more.

We feel Colonel Sanders pain.

Everything from Nood Co has been a ground up build. From product design to concrete composition, sealing to packaging, every step of the process was dreamt up, tested and approved by Nood Co.

When you buy Nood Co you are purchasing something unique. You are buying the process, the love we willingly commit, so you can experience something with soul.

Aw...



Meet The Team



Matt

PRODUCT DESIGNER & PROCUREMENT

Matt is Nood's lead product designer, responsible for determining the mood, colour and general vibration for the Nood aesthetic. His design / moral compass is aimed toward originality and genuine connection with the consumer.



Chris

PRODUCT DEVELOPMENT & HEAD OF MANUFACTURE

Chris is head of product development and manufacture. With an unrivalled understanding of chemical composition and material usage in chemical analysis, mechanical, concrete application, welding, manufacture and assembly, Chris makes it look easy, and it's seriously not.



Joelle

FRONT END MANAGER

Joelle is Nood Co's front end manager. Her extensive skill set includes product, graphic and web design, coding and copywriting...the list goes on. Joelle's knowledge of high-end furniture is unrivalled, and she leads a team readied to assist with your order.



Matt

MANUFACTURER

Matt co-runs the manufacture floor for Nood Co. Responsible for looking after the finesse of each handmade product, Matt drives our team of makers to ensure each piece of concrete is made with exact, precise love.



Connor

MANUFACTURER

Connor co-runs the manufacture floor at Nood Co HQ. An ever growing platform, Connor ensures the staff training is under constant monitor. With a trained eye for refinement and detail, you can thank Connor for Nood's exponential growth and consistent quality.



Meghan

STYLING & PHOTOGRAPHY

Meghan is a highly regarded product stylist and photographer. She is responsible for the Nood Co product styling and shoots. Her storytelling within each shot is breath taking, so if you like what you see, you can thank Meghan.



Claire

GRAPHIC DESIGN & BRAND DEVELOPMENT

Claire is an award winning graphic artist with a monster catalogue of original art, brand development and insane logo treatments. Her brand development is slick, super on trend and always completely original. A good portion of Nood's energy is Claire.



Renoy

ACCOUNTS

Renoy is the financial and strategic backbone of Nood Co. He directs the Nood management team with a sound understanding of cashflow and company scaling.



Cory

3D MODELLING & CADS

With a Masters qualified in Architecture, Cory aids the Nood design team in shaping up their visions into workable 3D models. Cory has a strong gauge for proportion, aesthetic and structural engineering.



Marc

PHOTOGRAPHY

Marc is a seasoned portrait and product shoot photographer. An important part of our brand is aptly presenting the ideals and culture that our products suggest. Nood doesn't get anymore Marc, and Marc doesn't get anymore Nood.

NOOD CO
CONCRETE FURNITURE

E info@noodco.com

P + 61 401 487 654

FB / noodco

IG @nood_co

ABN 31 166 430 173

ACN 166 430 173

REG 2013

NOODCO.FR
NOODCO.COM.AU

*Concrete designed and
manufactured in Australia.*